



SOCKET-TEST FOR
RF PACKAGES

63079 SERIES

01/07

SPECIFICATIONS:

INSULATOR: POLYPHENYLENE SULFIDE (PPS)

CONTACT: PFINODAL, SPRING TEMPERED
30u GOLD OVER 30u NICKEL.

THERMAL RANGE: -55°C to +200°C.

FEATURES:

REPAIRABLE.

VERY HIGH TEMPERATURE.

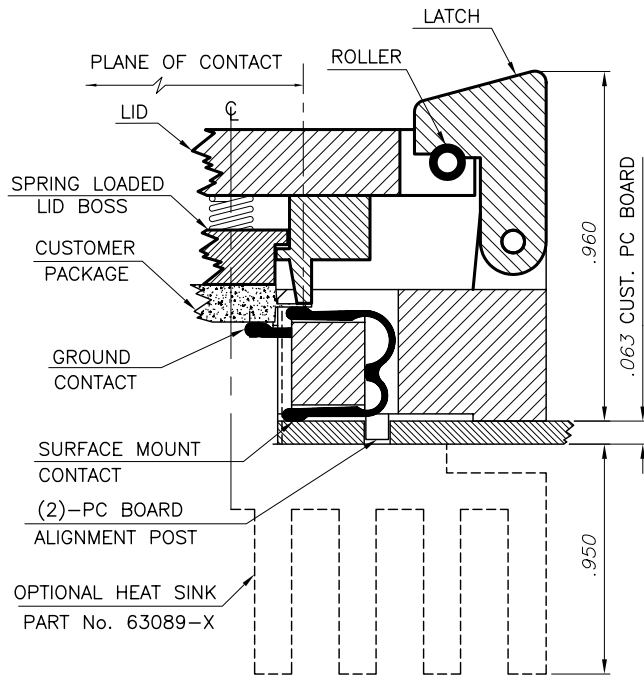
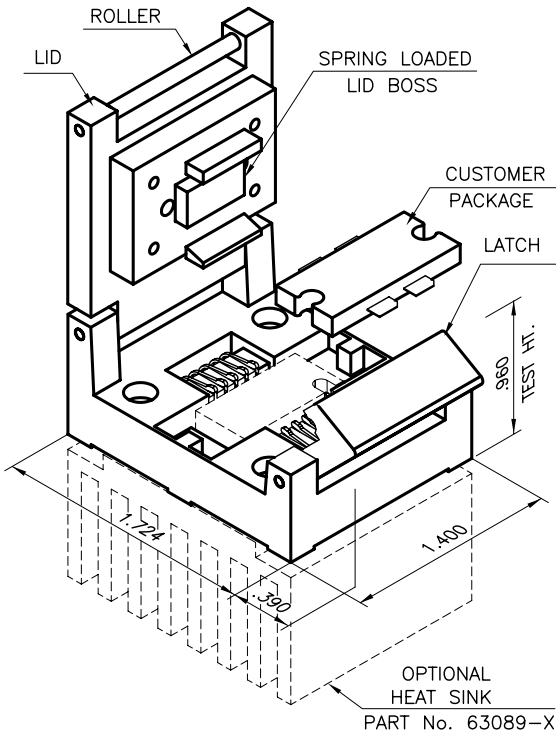

SECTION THRU CONTACT

SCALE: NTS

FOOTPRINT AVAILABLE UPON REQUEST

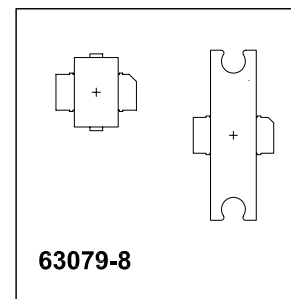
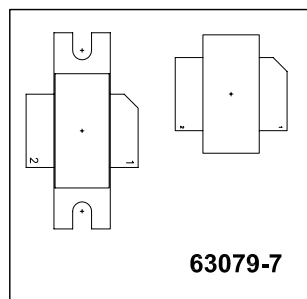
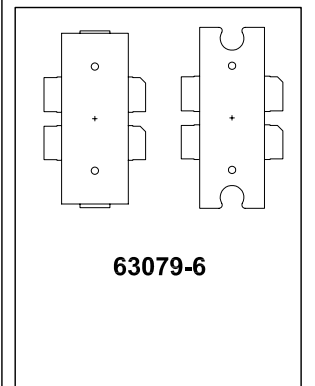
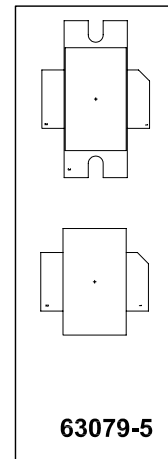
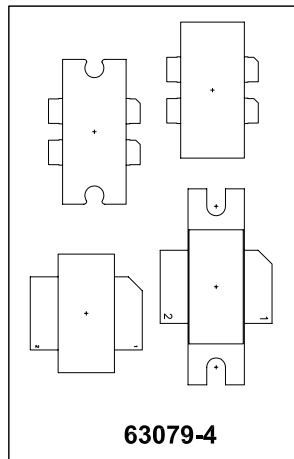
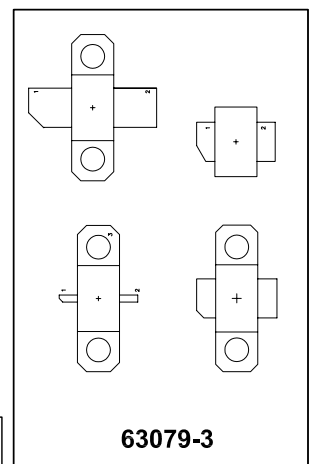
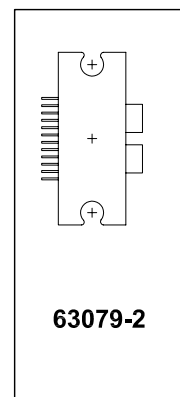
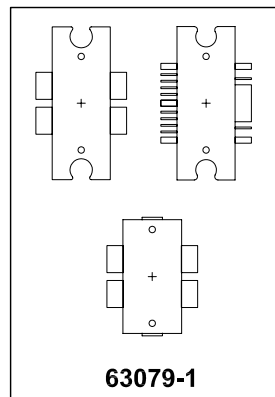

2605 S El Camino Real
San Clemente, CA 92672 USA

PH: 949.492.6481 FX: 949.492.0744
sales@azimuth-electronics.com
www.azimuth-electronics.com